

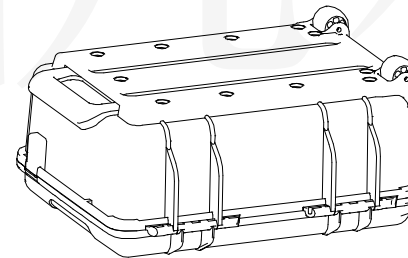

长河机箱
Changhe Enclosures

<http://www.enclosures.com.cn>

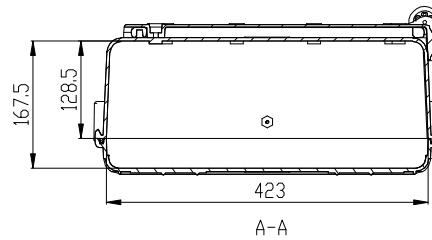
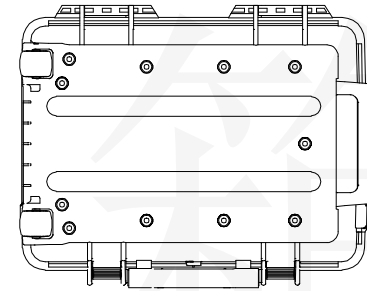
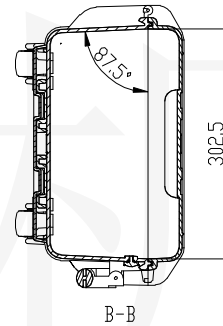
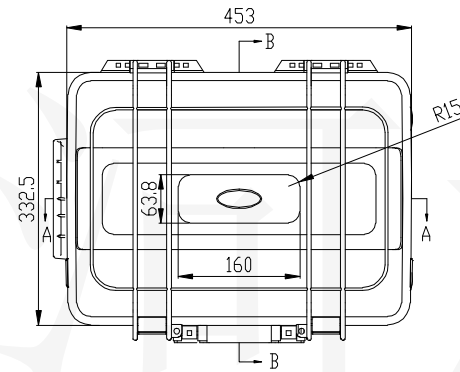
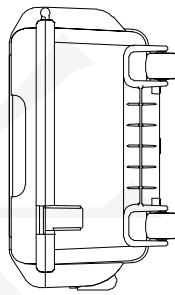
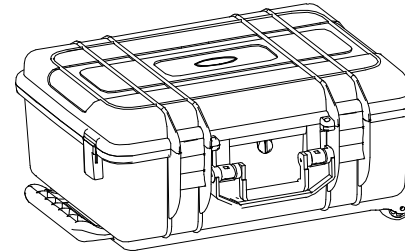
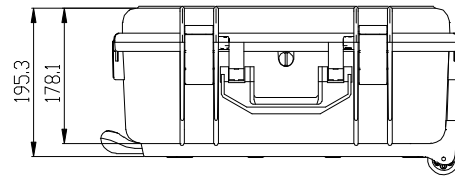

底图总号

D

旧底图总号

日期 签字

制图 Drawing	审核 Auditing	批准 Confirm	产品名称 Product Name	材料 Material	
			产品编号 Product Code	视图 Project View	(in m)
				图纸比例 Drawing Scale	1:6
共 张 第 张				宁波大洋壳体有限公司 Ningbo Dayang Enclosures CO., LTD	



长河机箱
Changhe Enclosures

<http://www.enclosures.com.cn>

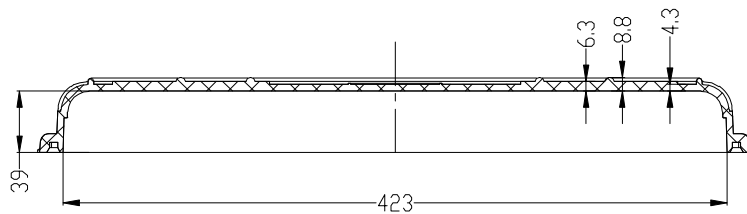
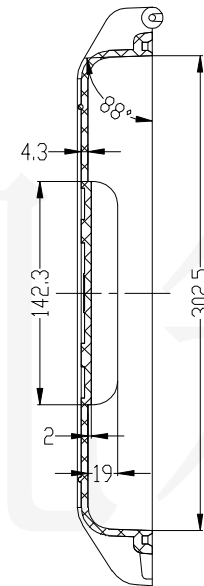
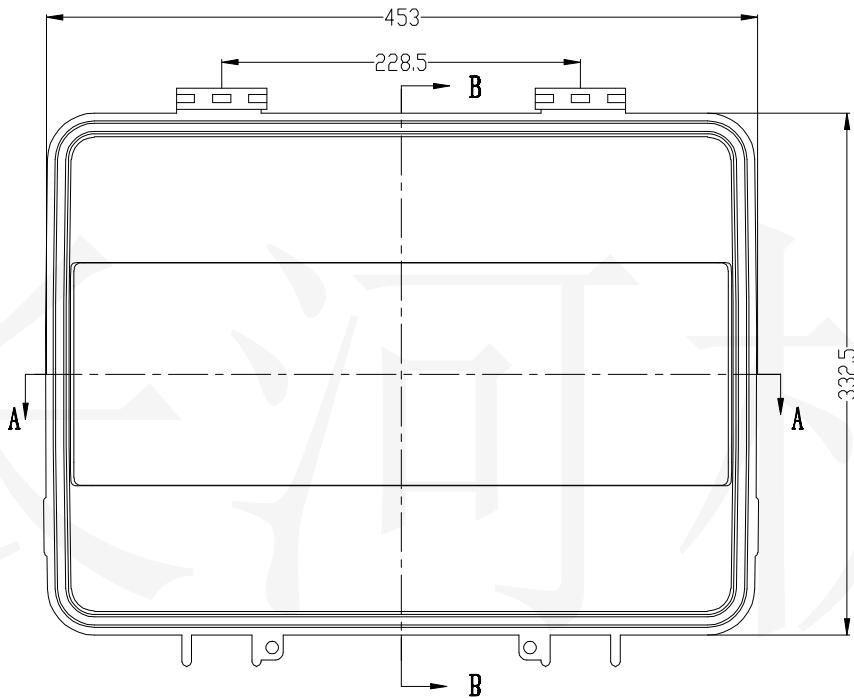

底图总号

D

旧底图总号

日期 签字

制图 Drawing	审核 Auditing	批准 Confirm	产品名称 Product Name	材料 Material
			产品编号 Product Code	视图 Project View
			37-6-1	(in m)
				图纸比例 Drawing Scale
				1:4
共 张 第 张			宁波大洋壳体有限公司 Ningbo Dayang Enclosures CO., LTD	



长河机箱
Changhe Enclosures

<http://www.enclosures.com.cn>

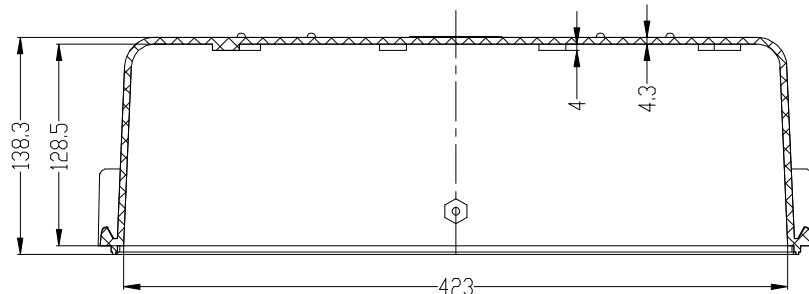
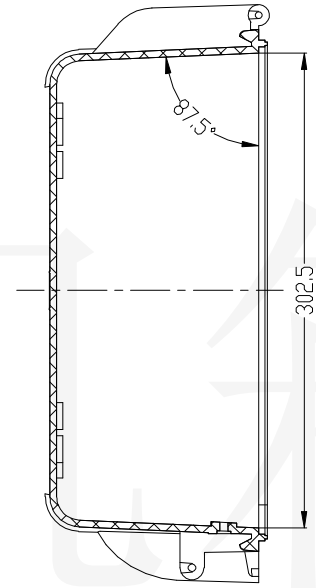
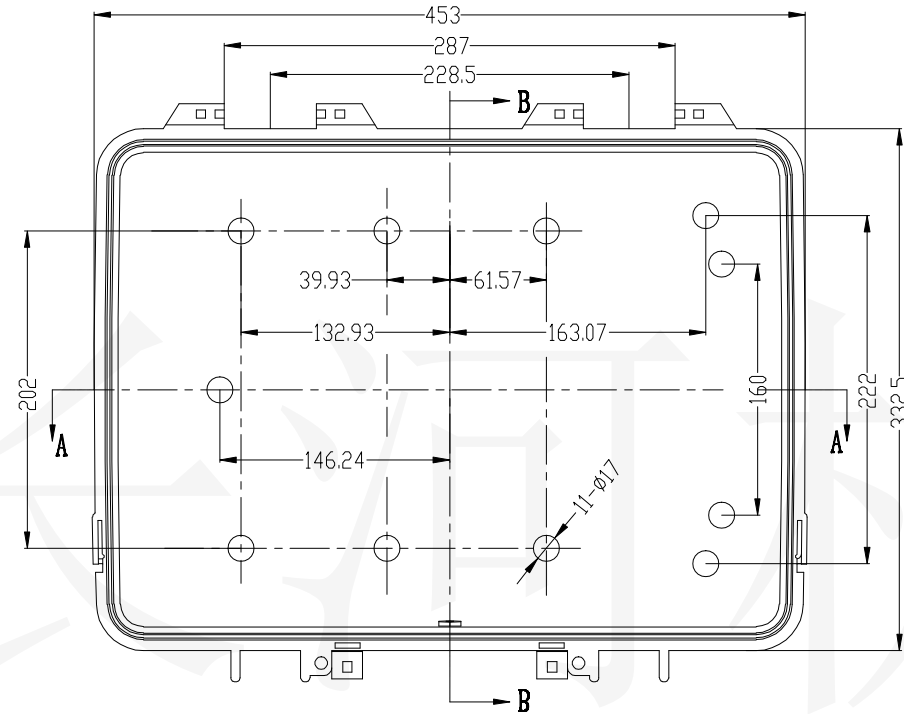

底图总号	
D	
旧底图总号	
日期	签字

制图 Drawing	审核 Auditing	批准 Confirm	产品名称 Product Name	材料 Material
			产品编号 Product Code	视图 Project View
			37-6-1	图纸比例 Drawing Scale
共 张 第 张			1:4	(m m)
			宁波大洋壳体有限公司 Ningbo Dayang Enclosures CO., LTD	